

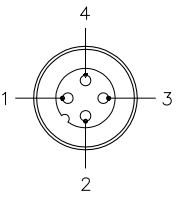

MALE END VIEW	FEMALE END VIEW	WIRING DIAGRAM	SPECIFICATIONS																					
			<table border="1"> <tr><td>CONTACT CARRIER MATERIAL</td><td>NYLON or TPU</td></tr> <tr><td>MOLDED HEAD MATERIAL/COLOR</td><td>TPU/YELLOW</td></tr> <tr><td>CONTACT MATERIAL/PLATING</td><td>BRASS/GOLD</td></tr> <tr><td>COUPLING NUT MATERIAL/FINISH</td><td>STAINLESS STEEL/PASSIVATED</td></tr> <tr><td>RATED CURRENT [A]</td><td>4.0 A</td></tr> <tr><td>RATED VOLTAGE [V]</td><td>250 V</td></tr> <tr><td>CONDUCTOR INSULATION MATERIAL</td><td>PVC</td></tr> <tr><td>NUMBER OF CONDUCTORS [AWG]</td><td>4x20 AWG</td></tr> <tr><td>TEMPERATURE RANGE</td><td>-40°C to +105°C (-40°F to +221°F)</td></tr> <tr><td>PROTECTION CLASS</td><td>NEMA 1,3,4,6P AND IEC IP67, IP69K</td></tr> </table>	CONTACT CARRIER MATERIAL	NYLON or TPU	MOLDED HEAD MATERIAL/COLOR	TPU/YELLOW	CONTACT MATERIAL/PLATING	BRASS/GOLD	COUPLING NUT MATERIAL/FINISH	STAINLESS STEEL/PASSIVATED	RATED CURRENT [A]	4.0 A	RATED VOLTAGE [V]	250 V	CONDUCTOR INSULATION MATERIAL	PVC	NUMBER OF CONDUCTORS [AWG]	4x20 AWG	TEMPERATURE RANGE	-40°C to +105°C (-40°F to +221°F)	PROTECTION CLASS	NEMA 1,3,4,6P AND IEC IP67, IP69K	
CONTACT CARRIER MATERIAL	NYLON or TPU																							
MOLDED HEAD MATERIAL/COLOR	TPU/YELLOW																							
CONTACT MATERIAL/PLATING	BRASS/GOLD																							
COUPLING NUT MATERIAL/FINISH	STAINLESS STEEL/PASSIVATED																							
RATED CURRENT [A]	4.0 A																							
RATED VOLTAGE [V]	250 V																							
CONDUCTOR INSULATION MATERIAL	PVC																							
NUMBER OF CONDUCTORS [AWG]	4x20 AWG																							
TEMPERATURE RANGE	-40°C to +105°C (-40°F to +221°F)																							
PROTECTION CLASS	NEMA 1,3,4,6P AND IEC IP67, IP69K																							
																								

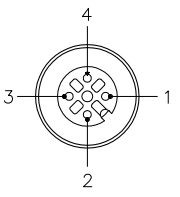
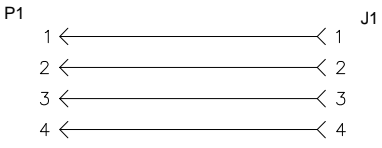

SOURCE DRAWING - FOR REFERENCE ONLY

RELATED DOCUMENTS 1. 2. 3. 4.	3RD ANGLE PROJECTION 	THIS DRAWING IS PROPERTY OF TURCK INC. USE OF THIS DOCUMENT WITHOUT WRITTEN PERMISSION IS PROHIBITED.	<div style="text-align: right;"> <p>3000 CAMPUS DRIVE MINNEAPOLIS, MN 55441 1-800-544-7769 (763) 553-7300 (763) 553-0708 fax turck.com</p> <p>TURCK INC High Technology Sensors and Automation Controls</p> </div>	
MATERIAL SEE SPECIFICATIONS	ALL DIMENSIONS DISPLAYED ON THIS DRAWING ARE FOR REFERENCE ONLY	DRFT RDS DATE 07/20/11 DSGN SCALE 1=1.0	DESCRIPTION RSCV RKCV 49	
FINISH SEE SPECIFICATIONS	CONTACT TURCK FOR MORE INFORMATION	UNIT OF MEASUREMENT MILLIMETER [INCH] IDENTIFICATION NO. U2-19090 REV A DO NOT SCALE THIS DRAWING FILE: U2-19090 SHEET 1 OF 1		

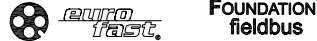
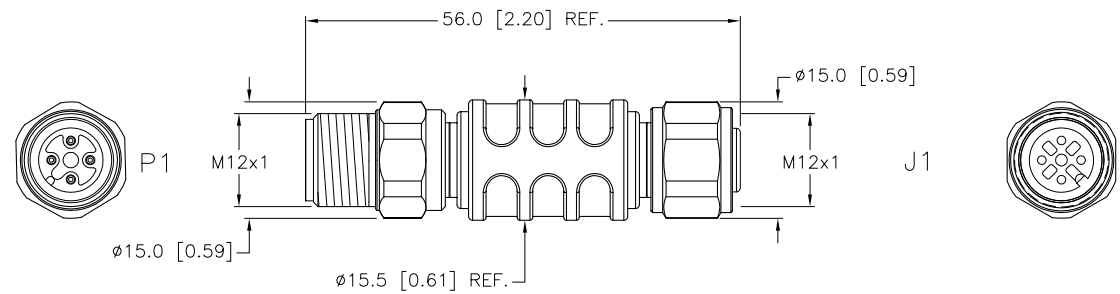
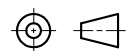
A	DRAWING RELEASE	RDS	07/22/11	
REV	DESCRIPTION	BY	DATE	ECO NO.